

Grease separator EasyClean ground NS 2, Direct, 550-950 mm, A/B, left

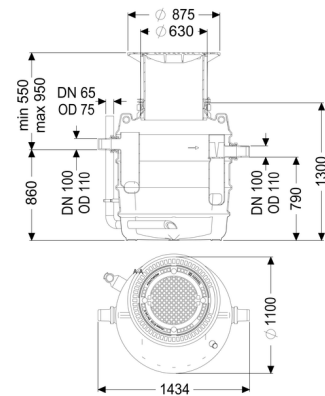
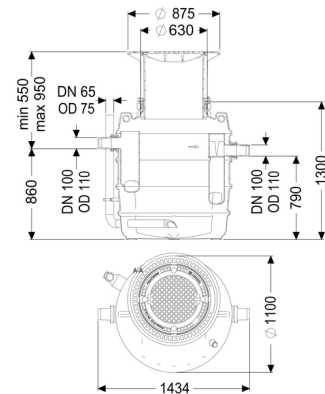

Article information

Item no.: 93002.80B-DL

GTIN: 4026092095072

Discount group: 03

Description

The separator for greasy wastewater is suitable for installation in the ground and comes without metallic components in the tank. The collecting tank made of permanently resistant polymer (PE) is equipped with an integrated sludge trap and has a rounded base for fast and clean disposal. Access for cleaning and maintenance work is possible via one or several service access covers.

A direct disposal pipe socket is available for odour-reduced manual disposal.

A load distribution slab must be installed on site for load class D. The reinforcement drawings are available from KESSEL AG.

20 year polyethylene warranty.
Installation situation:

underground installation

Version:

Type of disposal:	manual
Disposal system:	Disposal pipe
Disposal variant:	Direct
Nominal size (NS):	2
Load-bearing capacity (DIN 19901):	E2
Note on installation depth:	Installation in the ground, frost-free depth 800 mm
Delivery state:	Installation-ready (connection parts must be connected on site)

General characteristics:

Material:	PE
-----------	----

Dimensions:

Length:	1,380 mm
Width:	1,106 mm
Diameter:	1,106 mm

Tank:

Inlet nominal size (DN):	100
Outlet nominal size (DN):	100
Distance pipe bottom inlet to tank bottom:	860 mm
Distance pipe bottom outlet to tank bottom:	790 mm
Installation depth:	550 - 900 mm
Groundwater resistant from lower edge of base section:	500 mm
Clear width of entry (LW):	600 mm
Connection inlet/outlet sockets:	PE-HD pipes in accordance with DIN 19537, PVC-KG pipes in accordance with DIN 19534, PP or AS

Coverage features:

Type of cover:	Cover plate
Cover material:	Grey iron
Colour of cover:	black
Load class:	B 125 (EN 124)
Tightness:	odour-tight and surface water resistant

Wastewater contents:

Separator contents:	370 l
Contents of sludge trap:	200 l
Storage quantity of grease:	120 l
Storage quantity of light liquid:	120 l